

Actuator

92-
443.200



<https://www.eao.com/p/92-443.200>

Your product:



92-443.200 Actuator

FRONT

Front dimension:	18,8 mm x 18,8 mm
Front form:	Square
Front bezel colour:	Black
Front bezel material:	Plastic

MOUNTING

Design:	PCB
Mounting type:	Panel mounting

OPERATING-/INDICATION PART

Lens colour:	Red
Lens material:	Plastic
Lens illumination:	Illuminated
Lens shape:	Flush
Lens optics:	transparent
Illumination colour:	Red

ELECTRICAL CHARACTERISTICS

Switching voltage and switching current:	Switching voltage	min. 50 m VAC/DC max. 42 VAC/DC
	Switching current	min. 10 μ A AC/DC max. 100 mA AC/DC
	Power rating	max. 2 W
Switching rating:	42 V	
Electrical lifetime:		

500 000 cycles of operation at 42VDC, 50mA, according to IEC 6512-5-9c

Electric strength: 500 VAC, 50 Hz, 1 minute according to IEC 60512-5-9c

Electrostatic discharge (ESD): 15 kV

MECHANICAL CHARACTERISTIC

Switching action: Momentary

Switching system: Short-travel element

Switching system: Short-travel switching system with 2 independent contact points
Guarantees reliable switching even of very light loads. Fitted with 1 normally open contact.

Mechanical lifetime: ≥ 1 Mil. cycles of operation

Operating force: 2.7 N \pm 1 N switching element, 5 N lens

Operating Travel: ca. 0.4 mm switching element

Tightening torque: Fixing nut max. 0.5 Nm, Fixing screw mounting flange 0.4 Nm

Weight: 0.003 kg

AMBIENT CONDITION

IP front protection: IP67

IP Protection: IP67 front side

Operating temperature: - 25 °C ... + 70 °C

Storage temperature: - 40 °C ... + 80 °C

Shock resistance: Max. 500 m/s², pulse width, 3-axis (sinusoidal EN IEC 60068-2-27)

Vibration resistance: Max. 100 m / s² from 10 Hz ... 500 Hz, 10 cycles, 3-axis (sinusoidal EN IEC 60068-2-6)

CERTIFICATE

Approbations: CQC

Conformities: CE, UKCA, 2011 / 65 / EC (RoHS), 2014 / 35 / EU (LVD)

REACH: REACH compliant

RoHS: RoHS compliant

OTHER

Short Description: Actuator, 18,8 mm x 18,8 mm, Flush, Illuminated, Red, Plastic, transparent, Square, Black, Plastic, Momentary, IP67, Red

Dimension: 18.8 mm x 18.8 mm

Housing colour: White

Housing material: Plastic

Wiring diagrams:

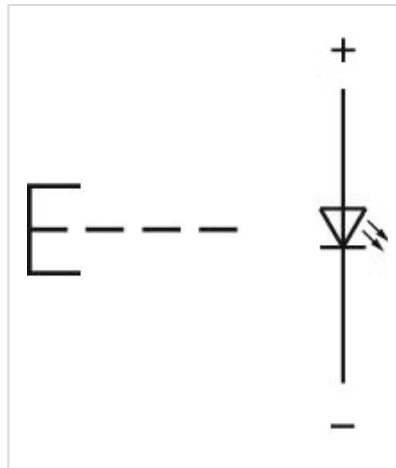

Mounting cut-outs:

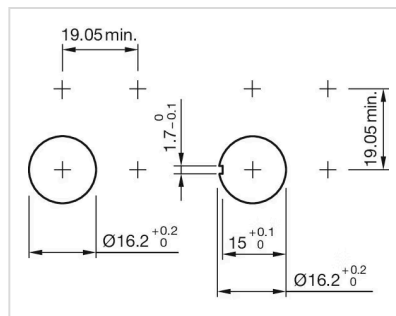

Dimension drawings:

