

Capacitive sensor switch with IO-Link Hygiene

84-ACKS-C16-04C3



<https://www.eao.com/p/84-ACKS-C16-04C3>

Your product:



84-ACKS-C16-04C3

Capacitive sensor switch with IO-Link Hygiene

FRONT

Front dimension:	Ø 30 mm
Front form:	Round
Front bezel material:	Stainless steel 316L

MOUNTING

Design:	Flush
Mounting cut-out:	Ø 22.5 mm
Mounting type:	Panel mounting

OPERATING-/INDICATION PART

Lens material:	Plastic
Lens illumination:	Illuminated
Lens shape:	Flush
Lens optics:	transparent
Symbol:	Standby (C16)

ELECTRICAL CHARACTERISTICS

Operating voltage:	8.4 - 32 V DC
Switching rating:	
Communication interface:	IO-Link specification

MECHANICAL CHARACTERISTIC

Terminal: Connector M12

Switching system: Capacitive

Operating force: No actuating force necessary

Weight: 0.015 kg

AMBIENT CONDITION

IP front protection: IP69K

IK front protection: IK08

Operating temperature: - 30 °C ... + 65 °C

Climate resistance: Relative humidity, max. 95%, non-condensing

CERTIFICATE

Approbations: CSA, EHEDG

Conformities: CE, UKCA

REACH: REACH compliant

RoHS: RoHS compliant

OTHER

Short Description: Capacitive sensor switch with IO-Link Hygiene, Ø 22.5 mm, Ø 30 mm, Flush, Illuminated, Plastic, transparent, Round, Stainless steel 316L, Connector M12, IP69K, IK08, Standby (C16)

Housing colour: Black

Housing material: Plastic

Wiring diagrams:

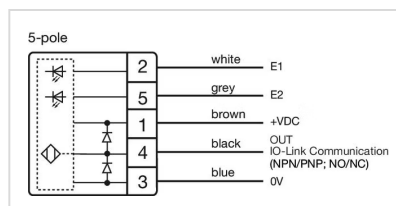
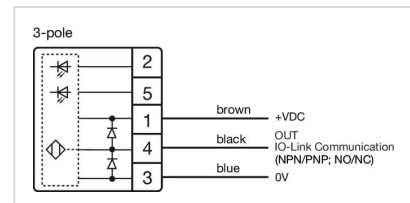
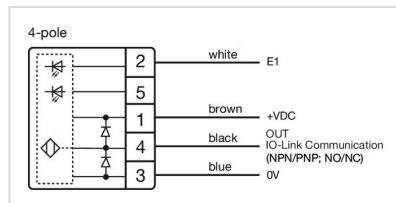

Component layouts:

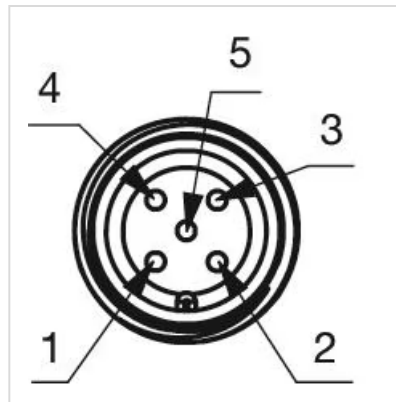
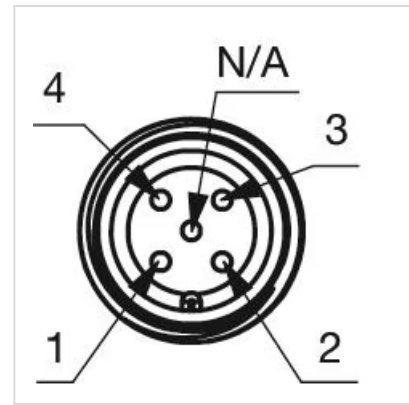
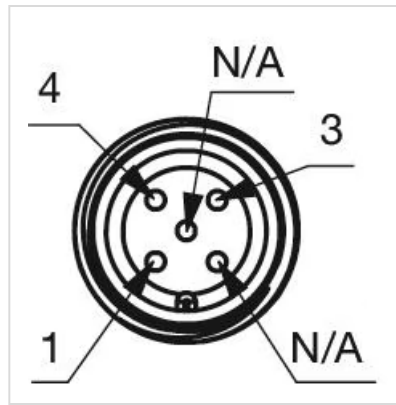

Mounting cut-outs:

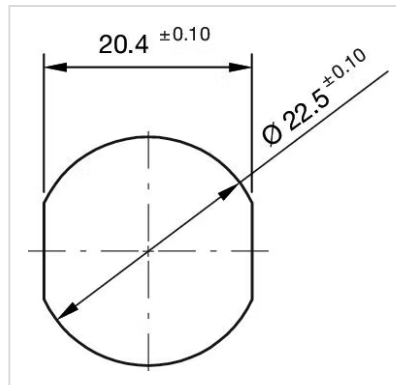

Dimension drawings:

